

PROJECT	_____
TYPE	_____
SPECIFIER	_____
QUANTITY	_____
DATE	_____

## VERSO 120-Q PORTABLE

### E10B0089- -

base number      Color      Finish  
 Temperature      Options

- To build a product code in our configurator select the specify button on the base model # product page
- To build a manual product code on this datasheet choose from the options listed below in blue font and add the suffix to the base model #

#### GENERAL

Series: Verso 120-Q  
 Partner: Side  
 Division: Exterior  
 Installation: Portable  
 Product Type: Bollard  
 Mounting Location: Above Ground  
 Light Distribution: Direct

#### PHYSICAL

Shape: Square  
 Length (mm): 120  
 Length (in): 4 ¾  
 Width (mm): 120  
 Width (in): 4 ¾  
 Height (mm): 235  
 Height (in): 9 ¼  
 Weight (kg): 2.3  
 Weight (lbs): 5.07  
 Diffuser: UV-stabilized opal glass screen  
 Gasket: Silicone rubber gaskets  
 Fixture Finish: [BLK](#) / [ANG](#) / [BRN](#)  
 Fixture Material: Aluminum Die Cast

#### ELECTRICAL

Lamp Type: LED (Zhaga Standard)  
 Input Wattage (W): 6  
 Dimming: Non-Dimming / Phase Dimming / 0-10V Dimming / DALI Dimming  
 Driver Included: Yes  
 Driver Location: Integrated  
 Driver Type: Constant Current - Universal  
 Driver Class: Class 2  
 Input Voltage (V): 120  
 Output Voltage (V): 24  
 Constant Current (MA): 500mA

#### LED

Color Temperature (°K): [3000](#) / [4000](#)  
 Max. Delivered Lumen (lm): 123 / 126  
 CRI: >90 CRI  
 Lamp Life (hrs): 50000

#### OPTICAL

Beam Angle: 90

#### RATINGS AND CERTIFICATIONS

Certified By: CSA Certified to UL and CSA Standards  
 IP rating: IP65  
 IK Rating: IK10

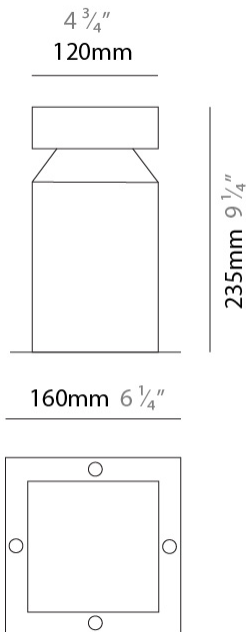

E10B0089-

PROJECT

TYPE

SPECIFIER

QUANTITY

DATE

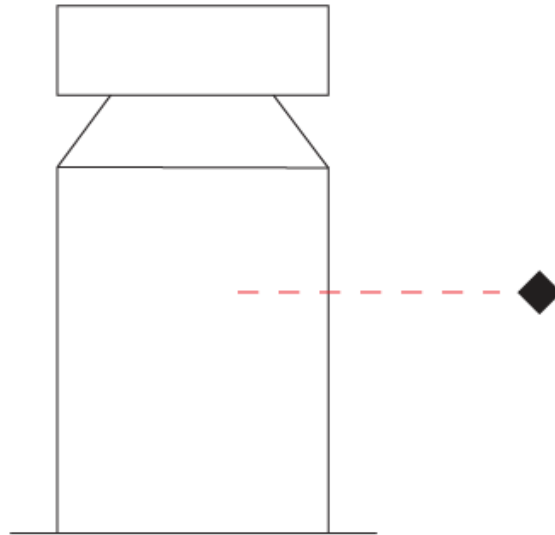

PROJECT	
TYPE	
SPECIFIER	
QUANTITY	
DATE	

## VERSO 120-Q PORTABLE

### E10B0090-

base number      Color      Finish  
 Temperature      Options

- To build a product code in our configurator select the specify button on the base model # product page
- To build a manual product code on this datasheet choose from the options listed below in blue font and add the suffix to the base model #

#### GENERAL

Series: Verso 120-Q  
 Partner: Side  
 Division: Exterior  
 Installation: Portable  
 Product Type: Bollard  
 Mounting Location: Above Ground  
 Light Distribution: Direct

#### PHYSICAL

Shape: Square  
 Length (mm): 120  
 Length (in): 4 ¾  
 Width (mm): 120  
 Width (in): 4 ¾  
 Height (mm): 235  
 Height (in): 9 ¼  
 Weight (kg): 3.1  
 Weight (lbs): 6.83  
 Diffuser: UV-stabilized opal glass screen  
 Gasket: Silicone rubber gaskets  
 Fixture Finish: [BLK](#) / [ANG](#) / [BRN](#)  
 Fixture Material: Aluminum Die Cast

#### ELECTRICAL

Lamp Type: LED (Zhaga Standard)  
 Input Wattage (W): 11  
 Dimming: Non-Dimming / Phase Dimming / 0-10V Dimming / DALI Dimming  
 Driver Included: Yes  
 Driver Location: Integrated  
 Driver Type: Constant Current - Universal  
 Driver Class: Class 2  
 Input Voltage (V): 120  
 Output Voltage (V): 24  
 Constant Current (MA): 500mA

#### LED

Color Temperature (°K): [3000](#) / [4000](#)  
 Max. Delivered Lumen (lm): Max 240  
 CRI: >90 CRI  
 Lamp Life (hrs): 50000

#### OPTICAL

Beam Angle: 180

#### RATINGS AND CERTIFICATIONS

Certified By: CSA Certified to UL and CSA Standards  
 IP rating: IP65  
 IK Rating: IK10

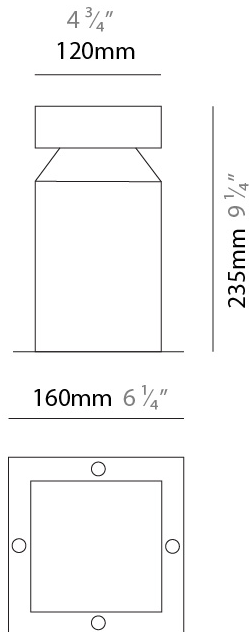

E10B0090-

PROJECT
TYPE
SPECIFIER
QUANTITY
DATE

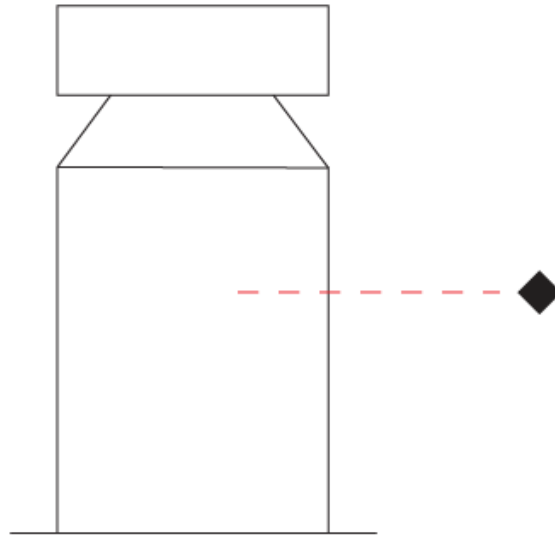

PROJECT	_____
TYPE	_____
SPECIFIER	_____
QUANTITY	_____
DATE	_____

## VERSO 120-Q PORTABLE

### E10B0091- -

base number      Color      Finish  
 Temperature      Options

- To build a product code in our configurator select the specify button on the base model # product page
- To build a manual product code on this datasheet choose from the options listed below in blue font and add the suffix to the base model #

#### GENERAL

Series: Verso 120-Q  
 Partner: Side  
 Division: Exterior  
 Installation: Portable  
 Product Type: Bollard  
 Mounting Location: Above Ground  
 Light Distribution: Direct

#### PHYSICAL

Shape: Square  
 Length (mm): 120  
 Length (in): 4 ¾  
 Width (mm): 120  
 Width (in): 4 ¾  
 Height (mm): 235  
 Height (in): 9 ¼  
 Weight (kg): 3.1  
 Weight (lbs): 6.83  
 Diffuser: UV-stabilized opal glass screen  
 Gasket: Silicone rubber gaskets  
 Fixture Finish: [BLK](#) / [ANG](#) / [BRN](#)  
 Fixture Material: Aluminum Die Cast

#### ELECTRICAL

Lamp Type: LED (Zhaga Standard)  
 Input Wattage (W): 23  
 Dimming: Non-Dimming / Phase Dimming / 0-10V Dimming / DALI Dimming  
 Driver Included: Yes  
 Driver Location: Integrated  
 Driver Type: Constant Current - Universal  
 Driver Class: Class 2  
 Input Voltage (V): 120  
 Output Voltage (V): 24  
 Constant Current (MA): 500mA

#### LED

Color Temperature (°K): [3000](#) / [4000](#)  
 Max. Delivered Lumen (lm): 448 / 462  
 CRI: >90 CRI  
 Lamp Life (hrs): 50000

#### OPTICAL

Beam Angle: 360

#### RATINGS AND CERTIFICATIONS

Certified By: CSA Certified to UL and CSA Standards  
 IP rating: IP65  
 IK Rating: IK10

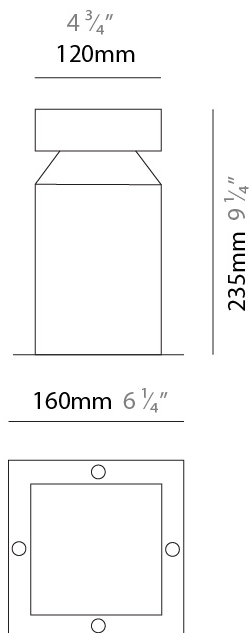

E10B0091-

PROJECT \_\_\_\_\_

TYPE \_\_\_\_\_

SPECIFIER \_\_\_\_\_

QUANTITY \_\_\_\_\_

DATE \_\_\_\_\_

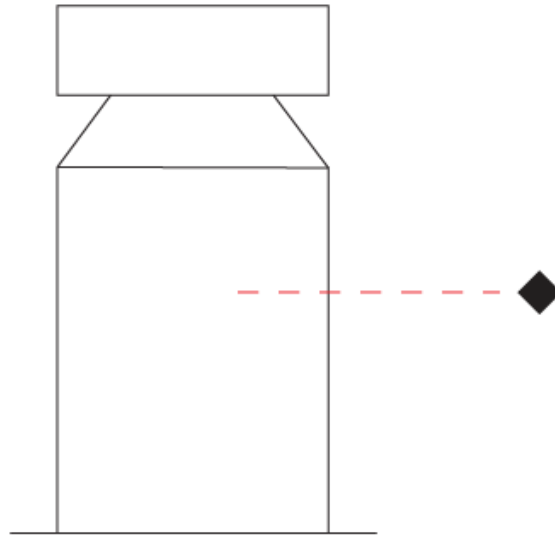

PROJECT
TYPE
SPECIFIER
QUANTITY
DATE

## VERSO 120-Q PORTABLE

### E10B0092-

base number      Color      Finish  
 Temperature      Options

- To build a product code in our configurator select the specify button on the base model # product page
- To build a manual product code on this datasheet choose from the options listed below in blue font and add the suffix to the base model #

#### GENERAL

Series: Verso 120-Q  
 Partner: Side  
 Division: Exterior  
 Installation: Portable  
 Product Type: Bollard  
 Mounting Location: Above Ground  
 Light Distribution: Direct

#### PHYSICAL

Shape: Square  
 Length (mm): 120  
 Length (in): 4 3/4  
 Width (mm): 120  
 Width (in): 4 3/4  
 Height (mm): 400  
 Height (in): 15 3/4  
 Weight (kg): 2.8  
 Weight (lbs): 6.17  
 Diffuser: UV-stabilized opal glass screen  
 Gasket: Silicone rubber gaskets  
 Fixture Finish: [BLK](#) / [ANG](#) / [BRN](#)  
 Fixture Material: Aluminum Die Cast

#### ELECTRICAL

Lamp Type: LED (Zhaga Standard)  
 Input Wattage (W): 6  
 Dimming: Non-Dimming / Phase Dimming / 0-10V Dimming / DALI Dimming  
 Driver Included: Yes  
 Driver Location: Integrated  
 Driver Type: Constant Current - Universal  
 Driver Class: Class 2  
 Input Voltage (V): 120  
 Output Voltage (V): 24  
 Constant Current (MA): 500mA

#### LED

Color Temperature (°K): [3000](#) / [4000](#)  
 Max. Delivered Lumen (lm): 123 / 118  
 CRI: >90 CRI  
 Lamp Life (hrs): 50000

#### OPTICAL

Beam Angle: 90

#### RATINGS AND CERTIFICATIONS

Certified By: CSA Certified to UL and CSA Standards  
 IP rating: IP65  
 IK Rating: IK10

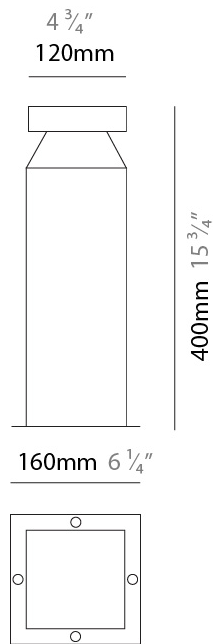

E10B0092-

PROJECT

TYPE

SPECIFIER

QUANTITY

DATE

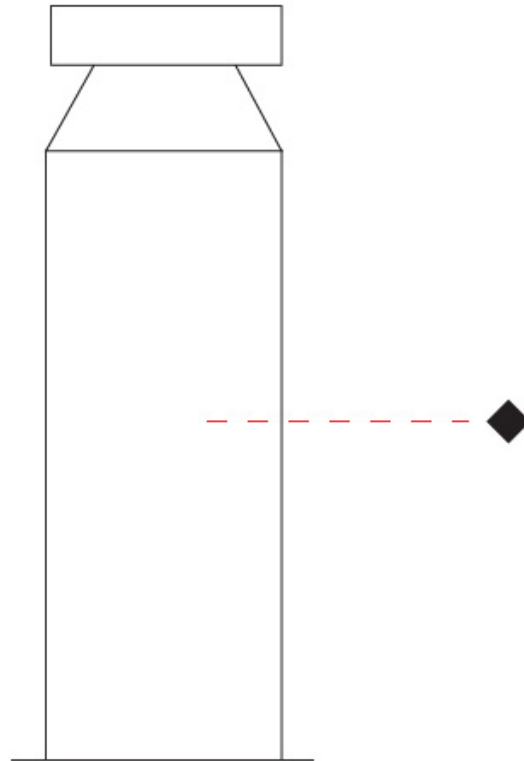

PROJECT
TYPE
SPECIFIER
QUANTITY
DATE

## VERSO 120-Q PORTABLE

### E10B0093-

base number      Color      Finish  
 Temperature      Options

- To build a product code in our configurator select the specify button on the base model # product page
- To build a manual product code on this datasheet choose from the options listed below in blue font and add the suffix to the base model #

#### GENERAL

Series: Verso 120-Q  
 Partner: Side  
 Division: Exterior  
 Installation: Portable  
 Product Type: Bollard  
 Mounting Location: Above Ground  
 Light Distribution: Direct

#### PHYSICAL

Shape: Square  
 Length (mm): 120  
 Length (in): 4 3/4  
 Width (mm): 120  
 Width (in): 4 3/4  
 Height (mm): 400  
 Height (in): 15 3/4  
 Weight (kg): 2.8  
 Weight (lbs): 6.17  
 Diffuser: UV-stabilized opal glass screen  
 Gasket: Silicone rubber gaskets  
 Fixture Finish: [BLK](#) / [ANG](#) / [BRN](#)  
 Fixture Material: Aluminum Die Cast

#### ELECTRICAL

Lamp Type: LED (Zhaga Standard)  
 Input Wattage (W): 11  
 Dimming: Non-Dimming / Phase Dimming / 0-10V Dimming / DALI Dimming  
 Driver Included: Yes  
 Driver Location: Integrated  
 Driver Type: Constant Current - Universal  
 Driver Class: Class 2  
 Input Voltage (V): 120  
 Output Voltage (V): 24  
 Constant Current (MA): 500mA

#### LED

Color Temperature (°K): [3000](#) / [4000](#)  
 Max. Delivered Lumen (lm): 233 / 222  
 CRI: >90 CRI  
 Lamp Life (hrs): 50000

#### OPTICAL

Beam Angle: 180

#### RATINGS AND CERTIFICATIONS

Certified By: CSA Certified to UL and CSA Standards  
 IP rating: IP65  
 IK Rating: IK10

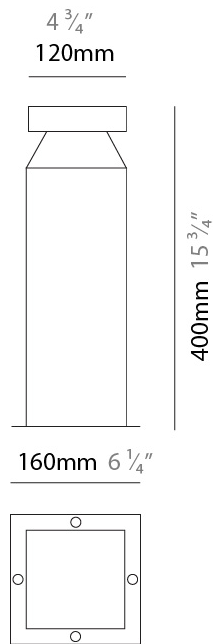

E10B0093-

PROJECT

TYPE

SPECIFIER

QUANTITY

DATE

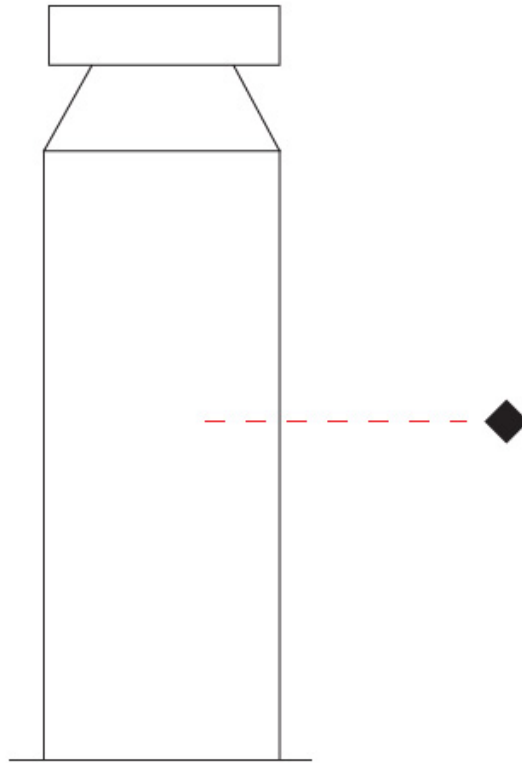

E

PROJECT
TYPE
SPECIFIER
QUANTITY
DATE

## VERSO 120-Q PORTABLE

### E10B0094-

base number      Color      Finish  
 Temperature      Options

- To build a product code in our configurator select the specify button on the base model # product page
- To build a manual product code on this datasheet choose from the options listed below in blue font and add the suffix to the base model #

#### GENERAL

Series: Verso 120-Q  
 Partner: Side  
 Division: Exterior  
 Installation: Portable  
 Product Type: Bollard  
 Mounting Location: Above Ground  
 Light Distribution: Direct

#### PHYSICAL

Shape: Square  
 Length (mm): 120  
 Length (in): 4 3/4  
 Width (mm): 120  
 Width (in): 4 3/4  
 Height (mm): 400  
 Height (in): 15 3/4  
 Weight (kg): 2.8  
 Weight (lbs): 6.17  
 Diffuser: UV-stabilized opal glass screen  
 Gasket: Silicone rubber gaskets  
 Fixture Finish: [BLK](#) / [ANG](#) / [BRN](#)  
 Fixture Material: Aluminum Die Cast

#### ELECTRICAL

Lamp Type: LED (Zhaga Standard)  
 Input Wattage (W): 23  
 Dimming: Non-Dimming / Phase Dimming / 0-10V Dimming / DALI Dimming  
 Driver Included: Yes  
 Driver Location: Integrated  
 Driver Type: Constant Current - Universal  
 Driver Class: Class 2  
 Input Voltage (V): 120  
 Constant Current (MA): 500mA

#### LED

Color Temperature (°K): [3000](#) / [4000](#)  
 Max. Delivered Lumen (lm): 448 / 453  
 CRI: >90 CRI  
 Lamp Life (hrs): 50000

#### OPTICAL

Beam Angle: 360

#### RATINGS AND CERTIFICATIONS

Certified By: CSA Certified to UL and CSA Standards  
 IP rating: IP65  
 IK Rating: IK10

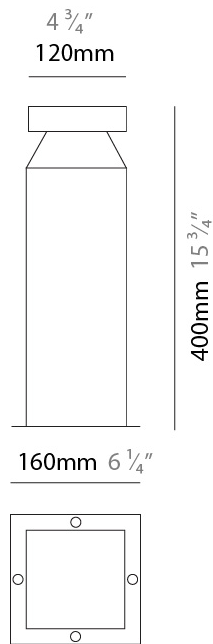

E10B0094-

PROJECT

TYPE

SPECIFIER

QUANTITY

DATE

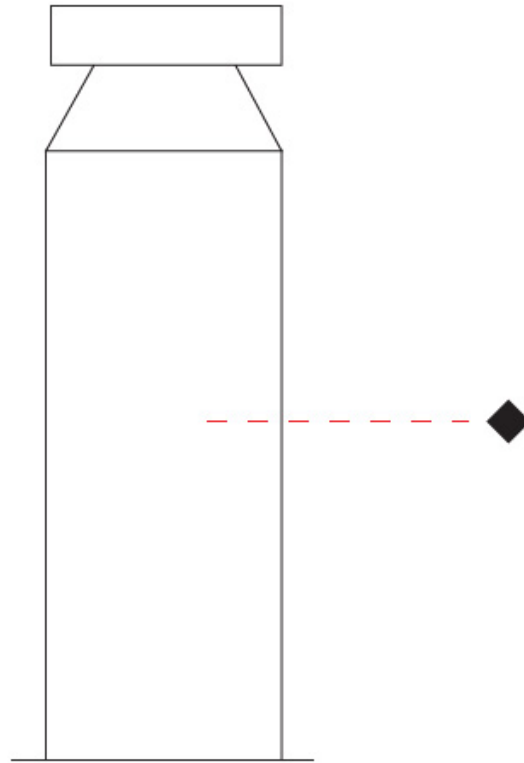

E

PROJECT
TYPE
SPECIFIER
QUANTITY
DATE

## VERSO 120-Q PORTABLE

### E10B0095-

base number      Color      Finish  
 Temperature      Options

- To build a product code in our configurator select the specify button on the base model # product page
- To build a manual product code on this datasheet choose from the options listed below in blue font and add the suffix to the base model #

#### GENERAL

Series: Verso 120-Q  
 Partner: Side  
 Division: Exterior  
 Installation: Portable  
 Product Type: Bollard  
 Mounting Location: Above Ground  
 Light Distribution: Direct

#### PHYSICAL

Shape: Square  
 Length (mm): 120  
 Length (in): 4 ¾  
 Width (mm): 120  
 Width (in): 4 ¾  
 Height (mm): 700  
 Height (in): 27 ½  
 Weight (kg): 3.9  
 Weight (lbs): 8.6  
 Diffuser: UV-stabilized opal glass screen  
 Gasket: Silicone rubber gaskets  
 Fixture Finish: [BLK](#) / [ANG](#) / [BRN](#)  
 Fixture Material: Aluminum Die Cast

#### ELECTRICAL

Lamp Type: LED (Zhaga Standard)  
 Input Wattage (W): 6  
 Dimming: Non-Dimming / Phase Dimming / 0-10V Dimming / DALI Dimming  
 Driver Included: Yes  
 Driver Location: Integrated  
 Driver Type: Constant Current - Universal  
 Driver Class: Class 2  
 Input Voltage (V): 120  
 Constant Current (MA): 500mA

#### LED

Color Temperature (°K): [3000](#) / [4000](#)  
 Max. Delivered Lumen (lm): 223 / 118  
 CRI: >90 CRI  
 Lamp Life (hrs): 50000

#### OPTICAL

Beam Angle: 90

#### RATINGS AND CERTIFICATIONS

Certified By: CSA Certified to UL and CSA Standards  
 IP rating: IP65  
 IK Rating: IK10

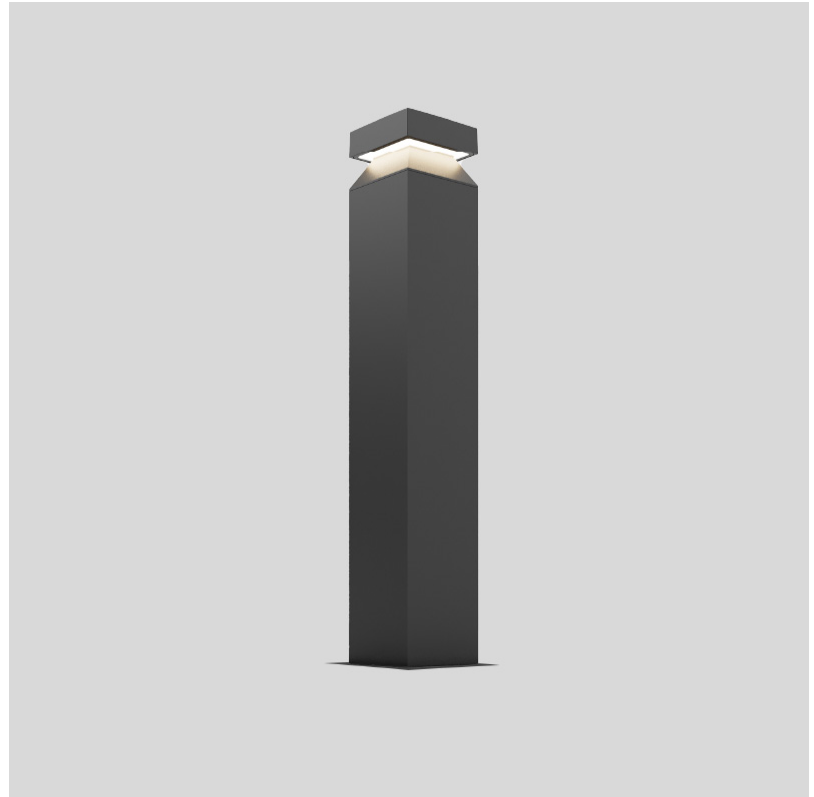

E10B0095-

PROJECT

TYPE

SPECIFIER

QUANTITY

DATE

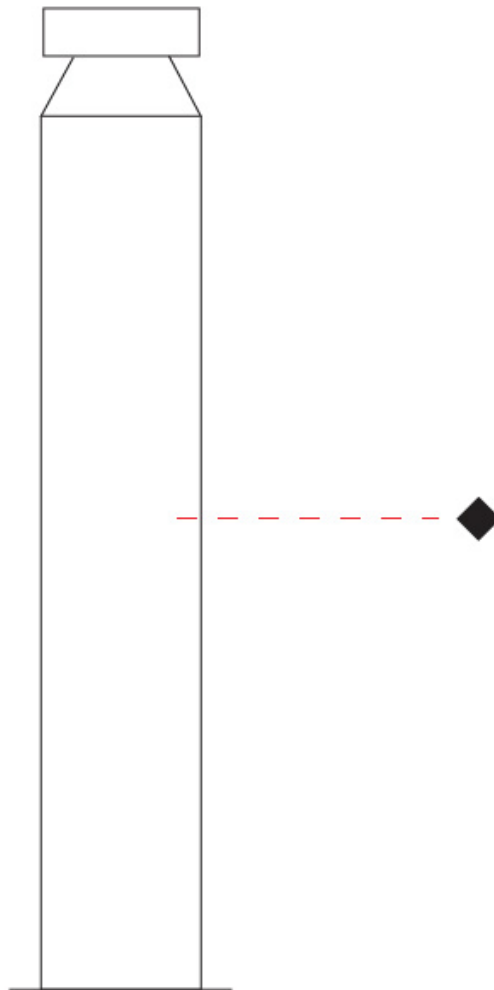

E

PROJECT
TYPE
SPECIFIER
QUANTITY
DATE

## VERSO 120-Q PORTABLE

### E10B0096-

base number      Color      Finish  
 Temperature      Options

- To build a product code in our configurator select the specify button on the base model # product page
- To build a manual product code on this datasheet choose from the options listed below in blue font and add the suffix to the base model #

#### GENERAL

Series: Verso 120-Q  
 Partner: Side  
 Division: Exterior  
 Installation: Portable  
 Product Type: Bollard  
 Mounting Location: Above Ground  
 Light Distribution: Direct

#### PHYSICAL

Shape: Square  
 Length (mm): 120  
 Length (in): 4 ¾  
 Width (mm): 120  
 Width (in): 4 ¾  
 Height (mm): 700  
 Height (in): 27 ½  
 Weight (kg): 3.9  
 Weight (lbs): 8.6  
 Diffuser: UV-stabilized opal glass screen  
 Gasket: Silicone rubber gaskets  
 Fixture Finish: [BLK](#) / [ANG](#) / [BRN](#)  
 Fixture Material: Aluminum Die Cast

#### ELECTRICAL

Lamp Type: LED (Zhaga Standard)  
 Input Wattage (W): 11  
 Dimming: Non-Dimming / Phase Dimming / 0-10V Dimming / DALI Dimming  
 Driver Included: Yes  
 Driver Location: Integrated  
 Driver Type: Constant Current - Universal  
 Driver Class: Class 2  
 Input Voltage (V): 120  
 Constant Current (MA): 500mA

#### LED

Color Temperature (°K): [3000](#) / [4000](#)  
 Max. Delivered Lumen (lm): 233 / 222  
 CRI: >90 CRI  
 Lamp Life (hrs): 50000

#### OPTICAL

Beam Angle: 180

#### RATINGS AND CERTIFICATIONS

Certified By: CSA Certified to UL and CSA Standards  
 IP rating: IP65  
 IK Rating: IK10

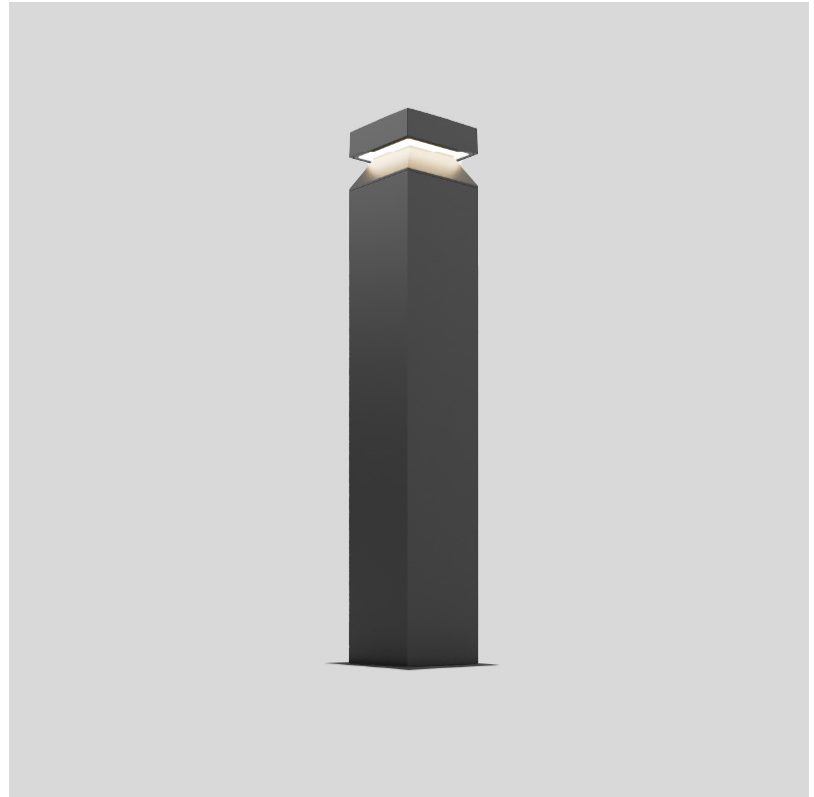

E10B0096-

PROJECT \_\_\_\_\_

TYPE \_\_\_\_\_

SPECIFIER \_\_\_\_\_

QUANTITY \_\_\_\_\_

DATE \_\_\_\_\_

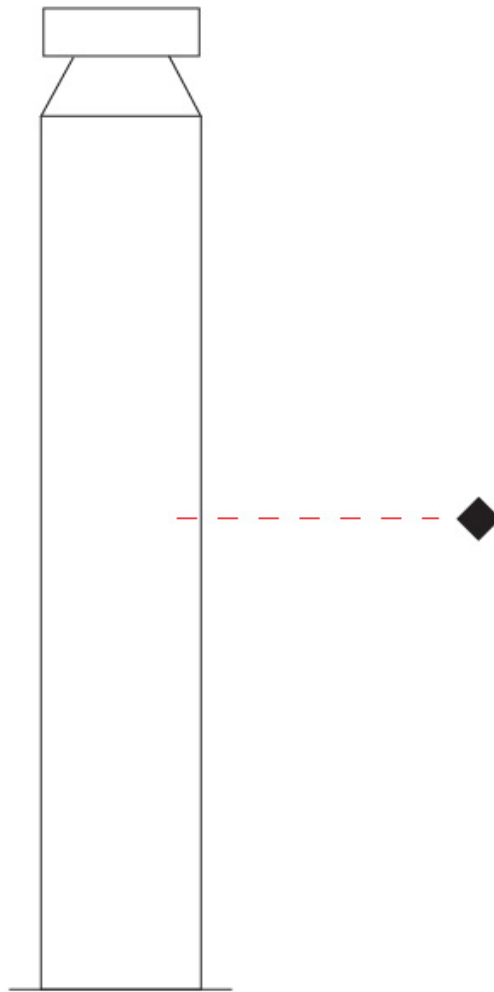

E

PROJECT
TYPE
SPECIFIER
QUANTITY
DATE

## VERSO 120-Q PORTABLE

### E10B0097- -

base number      Color      Finish  
 Temperature      Options

- To build a product code in our configurator select the specify button on the base model # product page
- To build a manual product code on this datasheet choose from the options listed below in blue font and add the suffix to the base model #

#### GENERAL

Series: Verso 120-Q  
 Partner: Side  
 Division: Exterior  
 Installation: Portable  
 Product Type: Bollard  
 Mounting Location: Above Ground  
 Light Distribution: Direct

#### PHYSICAL

Shape: Square  
 Length (mm): 120  
 Length (in): 4 ¾  
 Width (mm): 120  
 Width (in): 4 ¾  
 Height (mm): 700  
 Height (in): 27 ½  
 Weight (kg): 3.9  
 Weight (lbs): 8.6  
 Diffuser: UV-stabilized opal glass screen  
 Gasket: Silicone rubber gaskets  
 Fixture Finish: [BLK](#) / [ANG](#) / [BRN](#)  
 Fixture Material: Aluminum Die Cast

#### ELECTRICAL

Lamp Type: LED (Zhaga Standard)  
 Input Wattage (W): 23  
 Dimming: Non-Dimming / Phase Dimming / 0-10V Dimming / DALI Dimming  
 Driver Included: Yes  
 Driver Location: Integrated  
 Driver Type: Constant Current - Universal  
 Driver Class: Class 2  
 Input Voltage (V): 120 - 277  
 Constant Current (MA): 500mA

#### LED

Color Temperature (°K): [3000](#) / [4000](#)  
 Max. Delivered Lumen (lm): 448 / 453  
 CRI: >90 CRI  
 Lamp Life (hrs): 50000

#### OPTICAL

Beam Angle: 360

#### RATINGS AND CERTIFICATIONS

Certified By: CSA Certified to UL and CSA Standards  
 IP rating: IP65  
 IK Rating: IK10

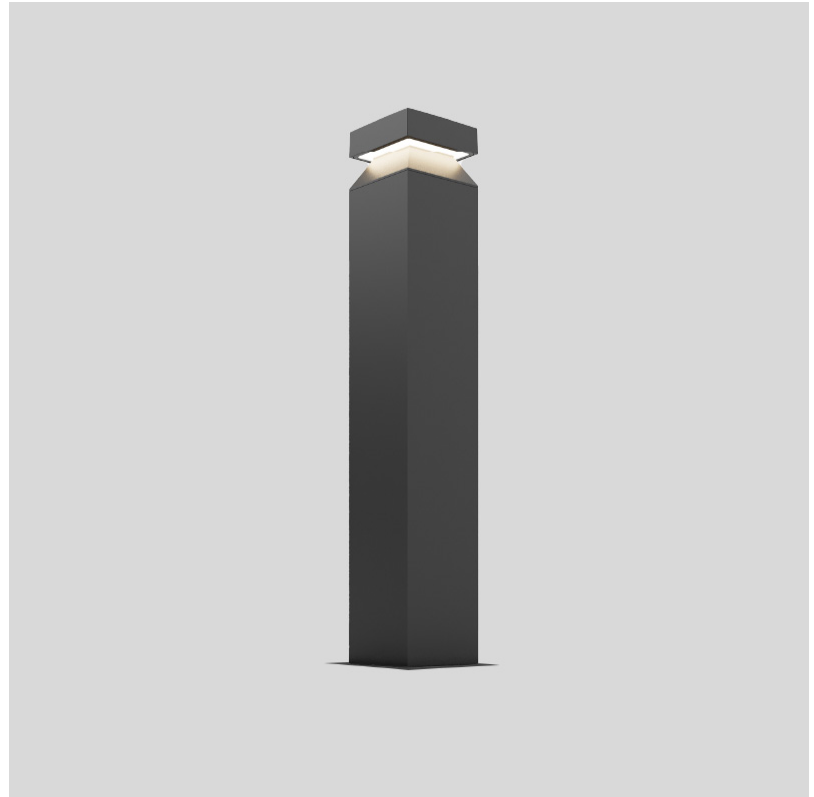

E10B0097-

PROJECT \_\_\_\_\_

TYPE \_\_\_\_\_

SPECIFIER \_\_\_\_\_

QUANTITY \_\_\_\_\_

DATE \_\_\_\_\_

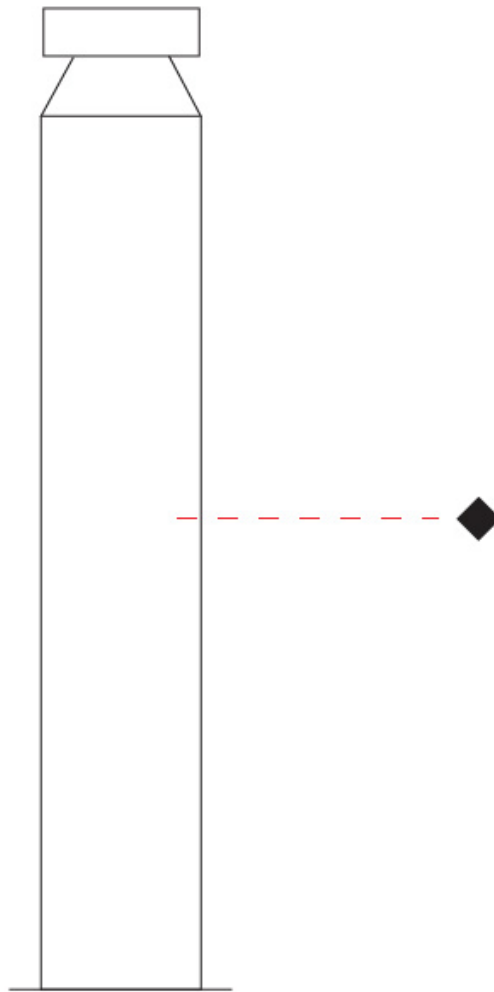

E

PROJECT
TYPE
SPECIFIER
QUANTITY
DATE

## VERSO 120-Q PORTABLE

### E10B0098-

base number      Color      Finish  
 Temperature      Options

- To build a product code in our configurator select the specify button on the base model # product page
- To build a manual product code on this datasheet choose from the options listed below in blue font and add the suffix to the base model #

#### GENERAL

Series: Verso 120-Q  
 Partner: Side  
 Division: Exterior  
 Installation: Portable  
 Product Type: Bollard  
 Mounting Location: Above Ground  
 Light Distribution: Direct

#### PHYSICAL

Shape: Square  
 Length (mm): 120  
 Length (in): 4 3/4  
 Width (mm): 120  
 Width (in): 4 3/4  
 Height (mm): 1000  
 Height (in): 39 3/8  
 Weight (kg): 4.9  
 Weight (lbs): 10.8  
 Diffuser: UV-stabilized opal glass screen  
 Gasket: Silicone rubber gaskets  
 Fixture Finish: [BLK](#) / [ANG](#) / [BRN](#)  
 Fixture Material: Aluminum Die Cast

#### ELECTRICAL

Lamp Type: LED (Zhaga Standard)  
 Input Wattage (W): 6  
 Dimming: Non-Dimming / Phase Dimming / 0-10V Dimming / DALI Dimming  
 Driver Included: Yes  
 Driver Location: Integrated  
 Driver Type: Constant Current - Universal  
 Driver Class: Class 2  
 Input Voltage (V): 120  
 Constant Current (MA): 500mA

#### LED

Color Temperature (°K): [3000](#) / [4000](#)  
 Max. Delivered Lumen (lm): 123 / 126  
 CRI: >90 CRI  
 Lamp Life (hrs): 50000

#### OPTICAL

Beam Angle: 90

#### RATINGS AND CERTIFICATIONS

Certified By: CSA Certified to UL and CSA Standards  
 IP rating: IP65  
 IK Rating: IK10

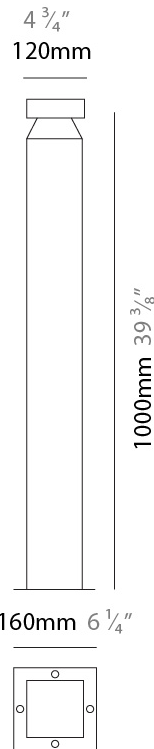
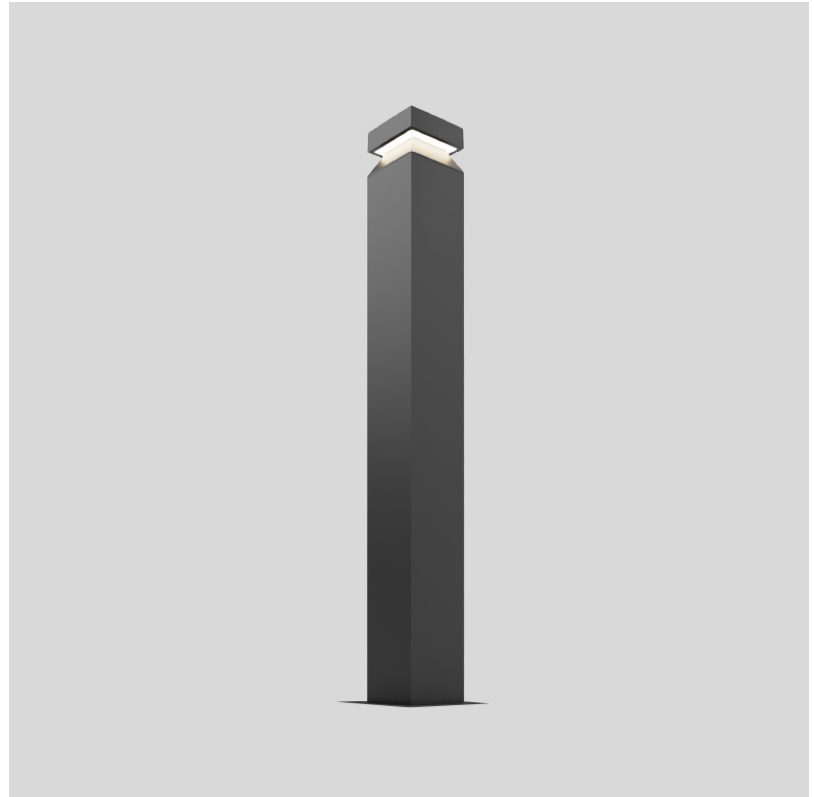

E10B0098-

PROJECT

TYPE

SPECIFIER

QUANTITY

DATE

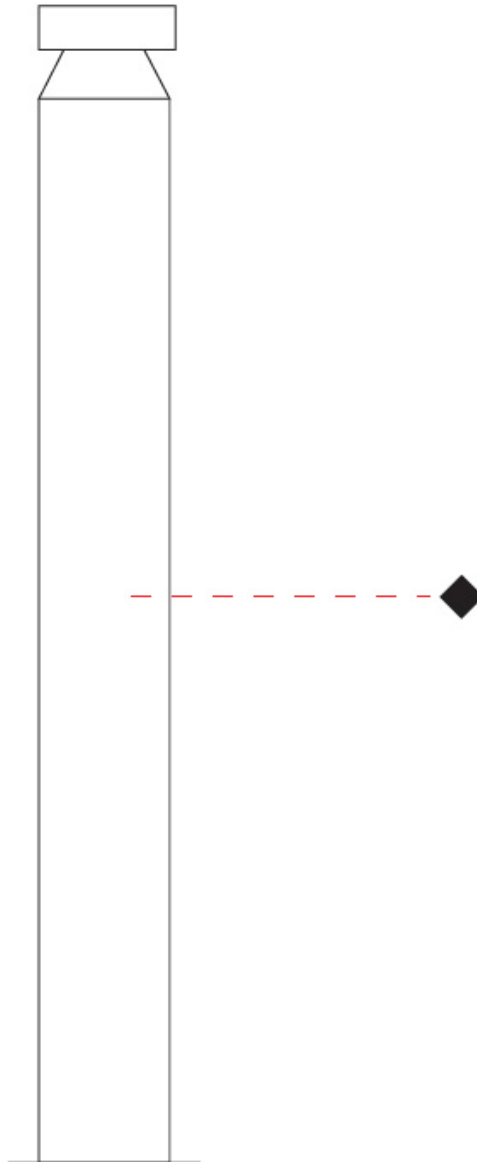

E

PROJECT
TYPE
SPECIFIER
QUANTITY
DATE

## VERSO 120-Q PORTABLE

### E10B0099-

base number      Color      Finish  
 Temperature      Options

- To build a product code in our configurator select the specify button on the base model # product page
- To build a manual product code on this datasheet choose from the options listed below in blue font and add the suffix to the base model #

#### GENERAL

Series: Verso 120-Q  
 Partner: Side  
 Division: Exterior  
 Installation: Portable  
 Product Type: Bollard  
 Mounting Location: Above Ground  
 Light Distribution: Direct

#### PHYSICAL

Shape: Square  
 Length (mm): 120  
 Length (in): 4 3/4  
 Width (mm): 120  
 Width (in): 4 3/4  
 Height (mm): 1000  
 Height (in): 39 3/8  
 Weight (kg): 4.9  
 Weight (lbs): 10.8  
 Diffuser: UV-stabilized opal glass screen  
 Gasket: Silicone rubber gaskets  
 Fixture Finish: [BLK](#) / [ANG](#) / [BRN](#)  
 Fixture Material: Aluminum Die Cast

#### ELECTRICAL

Lamp Type: LED (Zhaga Standard)  
 Input Wattage (W): 11  
 Dimming: Non-Dimming / Phase Dimming / 0-10V Dimming / DALI Dimming  
 Driver Included: Yes  
 Driver Location: Integrated  
 Driver Type: Constant Current - Universal  
 Driver Class: Class 2  
 Input Voltage (V): 120  
 Constant Current (MA): 500mA

#### LED

Color Temperature (°K): [3000](#) / [4000](#)  
 Max. Delivered Lumen (lm): 233 / 240  
 CRI: >90 CRI  
 Lamp Life (hrs): 50000

#### OPTICAL

Beam Angle: 180

#### RATINGS AND CERTIFICATIONS

Certified By: CSA Certified to UL and CSA Standards  
 IP rating: IP65  
 IK Rating: IK10

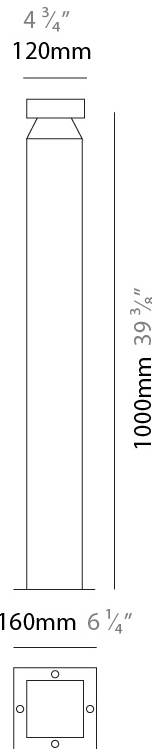
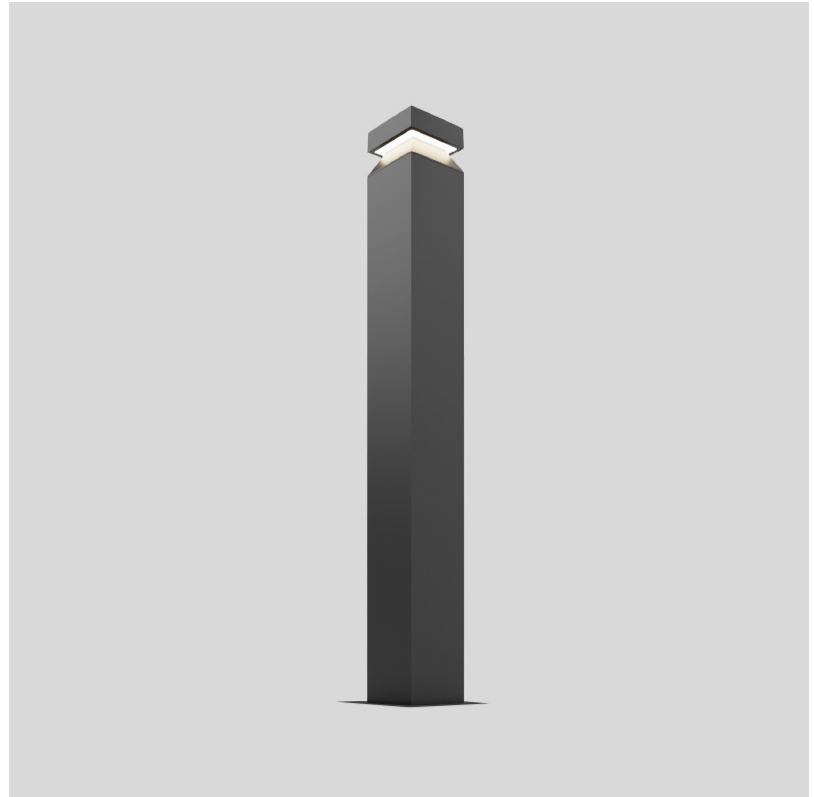

E10B0099-

PROJECT

TYPE

SPECIFIER

QUANTITY

DATE

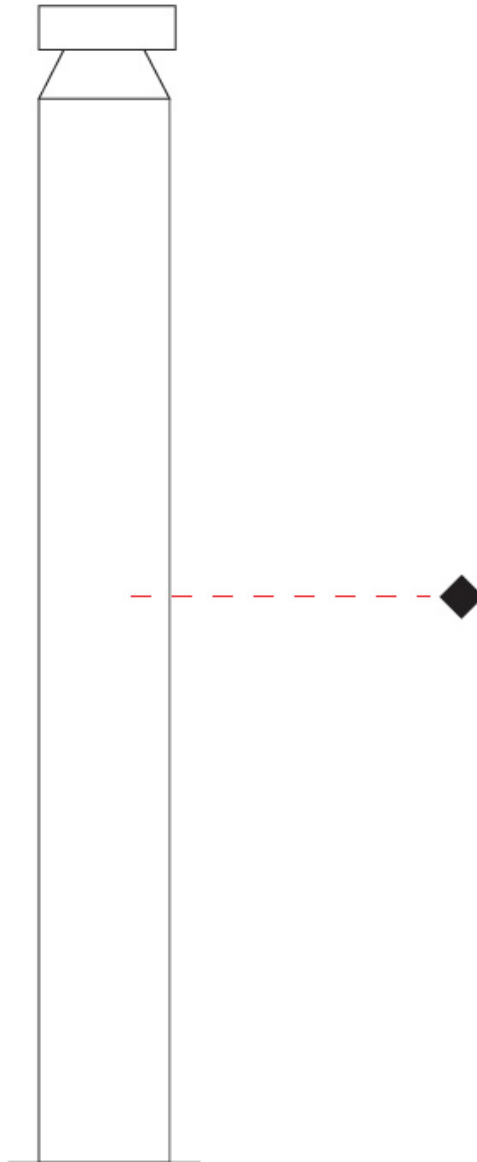

E

PROJECT
TYPE
SPECIFIER
QUANTITY
DATE

## VERSO 120-Q PORTABLE

### E10B0100- -

base number      Color      Finish  
 Temperature      Options

- To build a product code in our configurator select the specify button on the base model # product page
- To build a manual product code on this datasheet choose from the options listed below in blue font and add the suffix to the base model #

#### GENERAL

Series: Verso 120-Q  
 Partner: Side  
 Division: Exterior  
 Installation: Portable  
 Product Type: Bollard  
 Mounting Location: Above Ground  
 Light Distribution: Direct

#### PHYSICAL

Shape: Square  
 Length (mm): 120  
 Length (in): 4 3/4  
 Width (mm): 120  
 Width (in): 4 3/4  
 Height (mm): 1000  
 Height (in): 39 3/8  
 Weight (kg): 3.9  
 Weight (lbs): 10.8  
 Diffuser: UV-stabilized opal glass screen  
 Gasket: Silicone rubber gaskets  
 Fixture Finish: [BLK](#) / [ANG](#) / [BRN](#)  
 Fixture Material: Aluminum Die Cast

#### ELECTRICAL

Lamp Type: LED (Zhaga Standard)  
 Input Wattage (W): 23  
 Dimming: Non-Dimming / Phase Dimming / 0-10V Dimming / DALI Dimming  
 Driver Included: Yes  
 Driver Location: Integrated  
 Driver Type: Constant Current - Universal  
 Driver Class: Class 2  
 Input Voltage (V): 120  
 Constant Current (MA): 500mA

#### LED

Color Temperature (°K): [3000](#) / [4000](#)  
 Max. Delivered Lumen (lm): 448 / 462  
 CRI: >90 CRI  
 Lamp Life (hrs): 50000

#### OPTICAL

Beam Angle: 360

#### RATINGS AND CERTIFICATIONS

Certified By: CSA Certified to UL and CSA Standards  
 IP rating: IP65  
 IK Rating: IK10

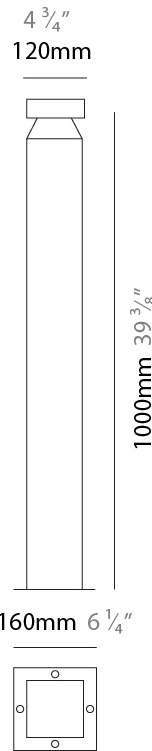
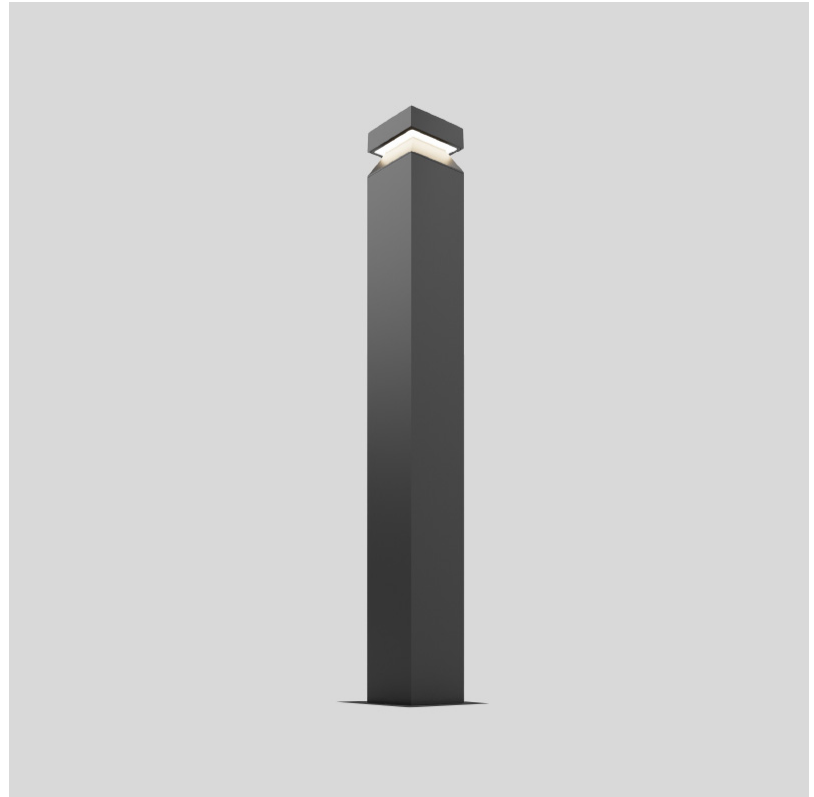

E10B0100-

PROJECT

TYPE

SPECIFIER

QUANTITY

DATE

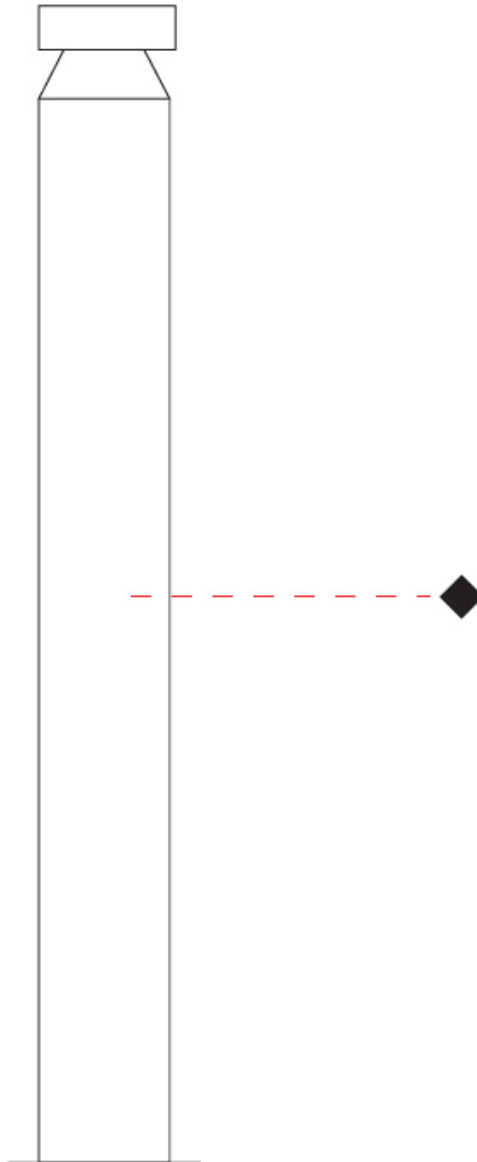

E

## VERSO 120-Q COLOR FINISH CHART

PROJECT \_\_\_\_\_

TYPE \_\_\_\_\_

SPECIFIER \_\_\_\_\_

QUANTITY \_\_\_\_\_

DATE \_\_\_\_\_

### Fixture Finish

Black - BLK

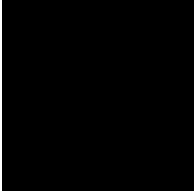

Brown - BRN

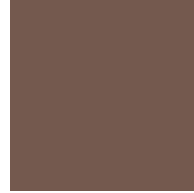

**Digital:** Not all screens are calibrated the same, and therefore, colors will appear differently between screens.

**Physical:** When texture is involved, there will be variations in color, character and tone within a product series and between product families.













### LEGEND

 floor-mounted	 pivotable	 special LED (upon request) RGB, RGBW, tunable, gold+, meat+, art+, fashion+
 wall and ceiling: recessed and surface mounted	 rotating	 warm dim / natural dimming LED
 ceiling-mounted and wall-mounted	 illuminate tilted	 rechargeable battery powered
 wall-mounted	 color of suspension cable	 fixture with natural vivid LED (upon request)
 omni-directional light distribution	 length of suspension cable	 color rendering index
 direct light distribution	 reflector degree selection	 color temperature
 direct/indirect light distribution	 super spot	 lumen (luminous flux)
 indirect light distribution	 lens	 efficacy (lumens per watt)
 asymmetric light distribution	 lens pack	 Unified Glare Rating (UGR) range from 5-40
 aura light distribution	 shine ring	 marine grade (AISI 316 stainless steel)
 round wall or ceiling cut-out	 integrated shine ring with diffuser	 walk on
 square wall or ceiling cut-out	 free individual colors 01-29	 drive on
 the supplied jig specifies the cutout dimensions	 individual colors: 00 (free of charge), 01-25 (extra charge)	 Dark Sky Compliance
 minimum distance (meters) lamp - object	 luminaire part to be colored (F1)	 Americans with Disabilities Act (less than 4" off the wall located between 27"-84" from floor)
 recessed depth	 luminaire part to be colored (F2)	 lamp protected against explosion
 ceiling thickness in mm	 luminaire part to be colored (F3)	 blown glass using traditional methods by master glass blower
 ceiling thickness selection	 luminaire part to be colored (F4)	 acoustic material
 dimmable DP (phase), DV (0-10V), DD (dali), DS (step-dim)	 luminaire part to be colored (F5)	 protection class I, protection insulation
 included or excluded LED driver/transformer/control gear	 color of 3-circuit adaptor	 protection class II, protection insulation
 separately switchable	 indirect diffuser	 ETL Certified to UL and CSA Standards
 sensor	 direct diffuser	 UL Certified to UL and CSA Standards
 remote control	 ball-proof (upon request)	 CSA Certified to UL and CSA Standards
 available upon request	 accessory	 Certified for North American Standards

### IP RATING

 IP20	protected against ingress of solid bodies greater than 12.5mm (finger)
 IP33	protected against ingress of solid bodies greater than 2.5mm protected against sprays of water up to 60 degrees from the vertical (rain)
 IP40	protected against ingress of solid bodies greater than 1mm (wire) no protection against the ingress of moisture
 IP43	protected against ingress of solid bodies greater than 1mm (wire) protected against sprays of water up to 60 degrees from the vertical (rain)
 IP44	protected against ingress of solid bodies greater than 1mm (wire) protected against water splashed from all directions
 IP54	protected against limited ingress of dust (wet rooms/covered outdoor areas) protected against water splashed from all directions
 IP65	protected against ingress of dust protected against jets of water
 IP66	protected against ingress of dust protected against powerful jets of water or heavy seas
 IP67	protected against ingress of dust protected against immersion of water between 15cm - 1m for 30 minutes
 IP68	protected against ingress of dust protected against immersion of water under pressure for long periods

### IK RATING

 IK01	protected against 0.14 joules impact (equivalent to 0.25kg mass dropped from 56mm above the surface)
 IK02	protected against 0.2 joules impact (equivalent to 0.25kg mass dropped from 80mm above the surface)
 IK03	protected against 0.35 joules impact (equivalent to 0.25kg mass dropped from 140mm above the surface)
 IK04	protected against 0.5 joules impact (equivalent to 0.25kg mass dropped from 200mm above the surface)
 IK05	protected against 0.7 joules impact (equivalent to 0.25kg mass dropped from 280mm above the surface)
 IK06	protected against 1 joules impact (equivalent to 0.25kg mass dropped from 400mm above the surface)
 IK07	protected against 2 joules impact (equivalent to 0.5kg mass dropped from 400mm above the surface)
 IK08	protected against 5 joules impact (equivalent to 1.7kg mass dropped from 300mm above the surface)
 IK09	protected against 10 joules impact (equivalent to 5.0kg mass dropped from 200mm above the surface)
 IK10	protected against 20 joules impact (equivalent to 5.0kg mass dropped from 400mm above the surface)